



PLAST METAL
FERROSOS E NÃO FERROSOS

FORNECEDOR DE

AÇO



A NOSSA HISTÓRIA

A Plastmetal, localizada em Contagem/MG, atua na distribuição de Metais Não Ferrosos, Aço, Ferro e Plásticos Industriais semi acabados. Criada em 2003, conta com amplo estoque, atendimento especializado e moderno maquinário para Serviços de Corte conforme desenho ou amostra, tais como: Jato de Água, Laser e Plasma. Nosso crescimento é resultado da busca pelo nosso objetivo central: a satisfação do cliente.

(31) 3352-5950 

www.plastmetal.com.br 



ÍNDICE

TUBOS INDUSTRIAIS	4
TUBOS DE GRANDES DIÂMETROS.....	6
ELETRODUTO GALVANIZADO.....	7
BARRAS TREFILADAS.....	8
OBLONGOS.....	9
BARRAS CHATAS.....	11
CANTONEIRAS ABAS IGUAIS.....	12
VIGAS U.....	13
PERFIL U.....	14
VIGAS I.....	16
PERFIL I.....	17
PERFIL T.....	18
TABELAS DE EQUIVALÊNCIA.....	19
NORMAS TÉCNICAS DE REFERÊNCIA.....	23
PROCESSO DE FABRICAÇÃO.....	24



TUBOS INDUSTRIAIS

Dimensão Externa mm	TUBO INDUSTRIAL QUADRADO E RETANGULAR																			
	ESPESSURA DA PAREDE(mm)																			
	QUADR.	RETANG.	0,90	1,06	1,20	1,50	2,00	2,25	2,65	3,00	3,35	3,75	4,25	4,75	5,60	6,30	7,11	9,52	12,70	
16x16			0,44	0,52	0,58	0,71	0,93													
20x20			0,54	0,64	0,72	0,88	1,16	1,29	1,49	1,66										
25x25	30x20		0,68	0,80	0,91	1,12	1,47	1,64	2,03	2,30										
	35x15		0,68	0,80	0,91	1,12	1,47	1,64	2,03	2,30										
30x30	40x20		0,83	0,97	1,09	1,36	1,78	1,99	2,44	2,76										
35x35	40x30		0,97	1,14	1,28	1,59	2,10	2,34	2,85	3,22										
	50x20		0,97	1,14	1,28	1,59	2,10	2,34	2,85	3,22										
40x40	50x30		1,11	1,30	1,47	1,82	2,41	2,69	3,15	3,36	3,92	4,60	5,21	5,82						
45x45	50x40		1,25	1,47	1,66	2,06	2,73	3,05	3,56	4,01	4,44	5,17	5,86	6,55						
	60x30		1,25	1,47	1,66	2,06	2,73	3,05	3,56	4,01	4,44	5,17	5,86	6,55						
	60x33		1,25	1,47	1,66	2,06	2,73	3,05	3,56	4,01	4,44	5,17	5,86	6,55						
50x50	60x40				1,84	2,29	3,03	3,40	3,98	4,48	4,97	5,75	6,51	7,28	8,58	9,73				
	70x30				1,84	2,29	3,03	3,40	3,98	4,48	4,97	5,75	6,51	7,28	8,58	9,73				
60x60	70x50				2,22	2,76	3,66	4,10	4,81	5,42	6,02	6,70	7,33	8,17	9,50	10,50				
	80x40				2,22	2,76	3,66	4,10	4,81	5,42	6,02	6,70	7,33	8,17	9,50	10,50				
	90x30				2,22	2,76	3,66	4,10	4,81	5,42	6,02	6,70	7,33	8,17	9,50	10,50				
63,5x63,5	80x50				2,98	3,96	4,46	5,22	5,89	6,54	7,29	8,21	9,11	10,10	10,83					
	80x60				3,35	4,37	4,84	5,67	6,34	7,00	7,83	8,67	9,67	11,16	12,34					
70x70	100x40				3,23	4,38	4,81	5,64	6,35	7,07	7,87	8,87	9,86	11,50	12,50					
75x75	100x50				3,43	4,57	5,15	6,03	6,81	7,57	8,44	9,51	10,57	12,35	13,78					
80x80	100x60				3,70	4,91	5,51	6,47	7,30	8,12	9,05	10,20	11,34	13,26	14,33	16,57	21,62			
	130x30				3,70	4,91	5,51	6,47	7,30	8,12	9,05	10,20	11,34	13,26	14,33	16,57	21,62			
90x90	100x80					5,55	6,22	7,34	8,23	9,17	10,22	11,53	12,83	15,01	16,34	18,79	24,60			
	120x60					5,55	6,22	7,30	8,23	9,17	10,22	11,53	12,83	15,01	16,78	18,79	24,60			
	120x40								7,97	8,11	9,04	10,20	11,34	13,25	14,80	16,56	21,62	27,84		
	120x80					6,12	7,00	8,17	9,17	10,17	11,34	12,67	14,16	15,50	17,34	18,79	24,60			
	120x100								10,11	11,26	12,57	14,20	15,81	18,52	20,70	23,25	30,56	39,77		
	140x80					6,79	7,63	8,96	10,12	11,30	12,65	14,25	15,81	18,52	20,73	23,25	30,57	39,78		
100x100	150x50					6,16	6,92	8,17	9,17	10,22	11,40	12,87	14,32	16,77	18,75	21,02	27,58	35,80		
	150x80					7,10	7,99	9,41	10,59	11,84	13,25	14,98	16,33	19,40	21,72	24,36	32,06	41,77		
	180x80								11,99	13,36	14,92	16,86	18,78	22,02	24,67	27,70	36,52	47,73		
	150x100					7,73	8,68	10,20	11,53	12,87	14,34	16,20	18,04	21,15	23,69	26,59	35,04	45,74		
120x120	200x40					6,92	8,33	9,79	11,05	12,31	13,75	15,53	17,30	20,27	22,70	25,47	33,55	43,75		
130x130	200x60					7,51	9,04	10,62	11,99	13,36	14,92	16,86	18,78	22,03	24,67	27,70	36,52	47,73		
	160x80								11,06	12,35	13,82	15,66	17,30	20,39	22,70	25,48	33,55	43,76		
140x140	160x120								12,93	14,41	16,09	18,19	20,27	23,78	26,64	29,93	39,51	51,71		
	200x80								12,93	14,41	16,09	18,19	20,27	23,78	26,64	29,93	39,51	51,71		
150x150	180x120								13,87	15,46	17,27	19,52	21,76	25,53	28,62	32,15	42,49	55,68		
	200x100								13,87	15,46	17,27	19,52	21,76	25,53	28,62	32,15	42,49	55,68		
160x160									14,81	16,51	18,44	20,85	23,25	27,29	30,59	34,38	45,47	59,66		
180x180									16,69	18,61	20,79	23,51	26,22	30,79	34,54	38,83	51,43	67,62		
190x190									17,63	19,66	21,97	24,84	27,71	32,55	36,71	41,06	54,41	71,59		
	200x150								16,22	18,11	20,27	22,96	25,48	29,92	33,55	37,73	49,95	65,63		
200x200	250x150								18,77	20,71	23,14	26,18	29,20	34,31	38,48	43,29	57,40	75,57		
	300x100								18,77	20,71	23,14	26,18	29,20	34,31	38,48	43,29	57,40	75,57		
250x250									23,27	25,98	29,07	32,93	36,64	43,08	48,35	54,43	72,31	95,46		
300x300									27,97	31,23	34,95	39,60	44,08	51,85	58,22	65,56	87,21	115,35		
350x350									32,67	36,48	40,83	45,59	50,95	60,01	67,51	76,69	102,12	135,24		
400x400									37,36	41,71	46,67	52,88	58,95	69,38	77,95	87,83	117,03	155,12		

TUBOS INDUSTRIAIS

TUBO INDUSTRIAL REDONDO																	
Bitola		ESPESSURA DA PAREDE(mm) kgs/mt															
pol	mm	0,90	1,20	1,50	1,90	2,00	2,25	2,65	3,00	3,3	3,75	4,25	4,73	5,50	5,60	6,30	7,11
3/8"	9,52	0,19	0,25	0,30													
1/2"	12,70	0,26	0,34	0,41													
5/8"	15,87	0,33	0,43	0,53	0,65	0,68											
3/4"	19,05	0,40	0,53	0,65	0,80	0,84	0,93	1,07	1,19								
13/16"	20,70	0,44	0,58	0,71	0,88	0,92	1,02	1,18	1,33								
	21,30			0,74	0,91	0,96	1,06	1,19	1,34								
7/8"	22,22	0,47	0,62	0,77	0,95	0,99	1,11	1,28	1,42								
1"	25,40	0,54	0,72	0,88	1,10	1,15	1,28	1,49	1,66	1,82	2,02						
	26,70			0,94	1,17	1,22	1,36	1,58	1,76	1,93	2,12						
	26,90			0,94	1,18	1,23	1,37	1,59	1,77	1,95	2,13						
1.1/8"	28,60	0,68	0,81	1,00	1,25	1,31	1,46	1,69	1,89	2,09	2,30						
1.1/4"	31,75	0,68	0,90	1,12	1,40	1,47	1,64	1,90	2,13	2,35	2,59						
	33,70			1,20	1,49	1,57	1,75	2,03	2,28	2,51	2,77	3,09	3,39				
1.3/8"	34,92	0,76	0,99	1,24	1,55	1,62	1,81	2,11	2,38	2,62	2,94	3,21	3,54				
1.1/2"	38,10	0,83	1,09	1,35	1,70	1,78	1,99	2,32	2,60	2,87	3,18	3,55	3,91				
1.5/8"	41,27	0,90	1,18	1,47	1,84	1,94	2,16	2,52	2,83	3,13	3,47	3,88	4,28				
	42,40			1,52	1,90	2,00	2,23	2,60	2,90	3,21	3,56	3,98	4,39				
1.3/4"	44,45	0,97	1,28	1,59	1,99	2,09	2,34	2,73	3,07	3,45	3,77	4,21	4,65	5,12			
1.7/8"	47,60	1,04	1,37	1,71	2,14	2,25	2,52	2,94	3,30	3,66	4,09	4,63	5,08	5,57			
	48,30			1,74	2,18	2,29	2,56	2,99	3,35	3,83	4,12	4,65	5,20	5,62	5,90	6,52	
2"	50,80	1,11	1,47	1,82	2,29	2,41	2,69	3,15	3,54	3,92	4,35	4,88	5,39	5,65	6,24	6,91	
2.1/4"	57,15	1,25	1,65	2,06	2,59	2,72	3,05	3,57	4,01	4,44	4,94	5,55	6,74	6,85	7,24	8,15	
2.3/8"	60,30	1,32	1,75	2,17	2,74	2,87	3,22	3,77	4,24	4,70	5,23	5,87	6,51	7,19	7,55	8,39	9,33
2.1/2"	63,50	1,38	1,84	2,29	2,89	3,03	3,40	3,98	4,47	4,97	5,53	6,21	6,88	7,61	7,99	8,89	9,75
2.3/4"	69,85	1,52	2,02	2,53	3,18	3,35	3,75	4,39	4,95	5,49	6,11	6,87	7,44	8,30	8,78	9,87	
2.7/8"	73,00					3,50	3,92	4,60	5,18	5,75	6,40	7,70	7,99	8,85	9,31	10,31	11,40
3"	76,20	1,71	2,22	3,10	3,48	3,66	4,27	4,81	5,42	6,02	6,70	7,53	8,42	9,27	9,75	10,86	
3.1/2"	88,90	1,94	2,59	3,23	4,09	4,29	4,81	5,64	6,35	7,07	7,87	8,87	9,86	10,93	11,50	12,83	
4"	101,60	2,23	2,97	3,70	4,67	4,91	5,51	6,47	7,30	8,11	9,05	10,20	11,34	12,59	12,76	14,80	16,55
4.1/2"	114,30			4,17	5,27	5,54	6,22	7,30	8,23	9,16	10,22	11,53	12,83	14,25	15,01	16,78	18,79
5"	127,00					6,16	6,94	8,12	9,17	10,21	11,40	12,86	14,32	15,91	16,77	18,75	21,02
5.1/2"	139,70					6,79	7,63	8,96	10,11	11,26	12,57	14,20	15,81	17,57	18,52	20,73	23,25
5.9/16"	141,30					6,83	7,71	9,06	10,23	11,40	12,72	14,36	15,99	17,75	18,74	20,98	23,53
6"	152,40					7,42	8,33	9,79	11,05	12,31	13,75	15,53	17,29	19,25	20,27	22,70	25,47
6.1/2"	165,10					8,04	9,03	10,62	11,99	13,36	14,92	16,86	18,78	20,88	22,03	24,67	27,70
6.5/8"	168,30					8,17	9,19	10,82	12,23	13,62	15,21	17,19	19,15	21,30	22,46	25,16	28,25
7"	177,80					8,66	9,74	11,44	12,93	14,45	16,09	18,19	20,27	22,54	23,78	26,64	29,93
8"	203,20					8,92	11,15	13,11	14,81	16,51	18,45	20,85	23,24	24,44	27,29	30,59	34,38
8.5/8"	219,30					10,70	12,04	14,16	16,00	17,84	19,93	22,54	25,13	26,42	29,51	33,09	37,20

TUBOS DE GRANDES

DIÂMETROS

TUBO SCHEDULE COM E SEM COSTURA											
Diâmetro Externo		20		40		60		80		160	
pol	mm	Esp	Kg/m	Esp	Kg/m	Esp	Kg/m	Esp	Kg/m	Esp	Kg/m
1/4	13,72	2,00	0,58	2,24	0,63			3,02	0,80		
3/8	17,15	2,00	0,75	2,31	0,85			3,20	1,10		
1/2	21,34	2,50	1,16	2,77	1,26			3,73	1,62	4,78	1,95
3/4	26,67	2,50	1,49	2,87	1,68			3,91	2,19	5,56	2,89
1	33,40	3,00	2,25	3,38	2,50			4,55	3,23	6,35	4,24
1.1/4	42,16	3,00	2,89	3,56	3,38			4,85	4,46	6,35	5,60
1.1/2	48,26	3,00	3,35	3,68	4,05			5,08	5,40	7,14	7,25
2	60,33	3,50	4,90	3,91	5,43			5,54	7,47	8,74	11,10
2.1/2	73,03	3,50	6,00	5,16	8,62			7,01	11,40	9,53	14,90
3	88,90	4,00	8,37	5,49	11,28			7,62	15,59	11,13	21,30
3.1/2	101,60	4,00	8,62	5,74	13,56			8,08	19,01		
4	114,30	4,00	10,90	6,02	16,06			8,56	22,77	13,49	33,51
5	141,30	5,00	16,80	6,55	21,76			9,53	31,59	15,88	49,05
6	168,28	5,00	20,31	7,11	28,23			10,97	43,42	18,26	67,47
8	219,08	6,35	33,28	8,18	42,49	10,31	53,07	12,70	65,95	23,01	111,18
10	273,05	6,35	41,73	9,27	60,24	12,70	81,46	15,09	96,01	28,56	172,11
12	323,85	6,35	49,68	10,31	79,71	14,27	108,97	17,48	132,08	33,32	238,60
14	355,60	7,92	67,98	11,13	94,31	15,09	126,51	19,05	158,10	35,71	281,49
16	406,40	7,92	77,92	12,70	123,18	16,66	160,04	21,44	203,26	40,49	364,94
18	457,20	7,92	87,85	14,27	155,90	19,05	205,62	23,83	254,24	45,24	459,67
20	508,00	9,53	116,97	15,09	183,14	20,62	247,78	26,19	311,17	50,01	564,96
22	558,80	9,53	129,01	15,88	212,52	22,22	294,04	28,57	374,04	53,97	672,73
24	609,60	9,53	140,81	17,48	254,74	24,61	354,62	30,96	442,08	59,54	807,79

DIN 2440 GALVANIZADO				
Nominal pol.	Externo m/m	Interno m/m	Parede m/m	Kg/m
3 / 8"	17,20	12,50	2,35	0,89
1 / 2"	21,30	16,00	2,65	1,27
3 / 4"	26,90	21,60	2,65	1,65
1"	33,70	27,20	3,25	2,55
1 1/4"	42,40	35,90	3,25	3,28
1 1/2"	48,30	41,80	3,25	3,77
2"	60,30	53,00	3,65	5,33
2 1/2"	76,10	68,80	3,65	6,80
3"	88,90	80,80	4,05	8,85
4"	114,30	105,30	4,50	12,64
5"	139,70	130,00	4,85	16,93
6"	165,10	155,40	4,85	20,06
8**	219,10	206,40	6,35	35,02

DIN 2440 PRETO				
Nominal pol.	Externo m/m	Interno m/m	Parede m/m	Kg/m
1 / 4"	13,50	8,80	2,35	0,65
3 / 8"	17,20	12,50	2,35	0,85
1 / 2"	21,30	16,00	2,65	1,22
3 / 4"	26,90	21,60	2,65	1,58
1"	33,70	27,20	3,25	2,44
1 1/4"	42,40	35,90	3,25	3,14
1 1/2"	48,30	41,80	3,25	3,61
2"	60,30	53,00	3,65	5,10
2 1/2"	76,10	68,80	3,65	6,51
3"	88,90	80,80	4,05	8,47
4"	114,30	105,30	4,50	12,10
5"	139,70	130,00	4,85	16,20
6"	165,10	155,40	4,85	19,20
8**	219,10	206,40	6,35	33,35

ELETRODUTO

GALVANIZADO

(NORMA NBR 5598, NBR 5597 E ANSI C80.1.)

Classe de espessura (mm) e peso de barras de 3m de comprimento

Diâmetro nominal		NBR 5597			NBR 5598		
Pol.	mm	Diâmetro externo mm	Espessura mm	Peso Kg	Diâmetro externo mm	Espessura mm	Peso Kg
1/2"	15	21,30	2,25	3,20	21,30	2,25	3,20
3/4"	20	26,70	2,25	4,32	26,90	2,25	4,32
1"	25	33,40	2,65	6,50	33,70	2,65	6,50
1.1/4"	32	42,20	3,00	9,41	42,40	3,00	9,41
1.1/2"	40	48,30	3,00	10,91	48,30	3,00	10,91
2"	50	60,30	3,35	15,45	60,30	3,35	15,45
2.1/2"	65	73,00	3,75	21,51	76,10	3,35	20,24
3"	80	88,90	3,75	25,87	88,70	3,75	25,87
3.1/2"	90	101,60	4,25	33,44	101,60	4,25	33,44
4"	100	114,30	4,25	37,85	114,30	4,25	37,85
5"	125	141,30	5,00	55,32	139,70	5,00	55,32
6"	150	168,30	5,30	70,74	165,10	5,00	70,74

BARRAS

TREFILADAS

TOLERÂNCIA DIMENSIONAL PARA BARRAS TREFILADAS

Dimensão Nominal (mm)		Tolerância (mm)					
Maior que	Até	ISO h7	ISO h8	ISO h9	ISO h10	ISO h11	ISO h12
1	3	-0.009	-0.014	-0.025	-0.040	-0.060	-0.090
3	6	-0.012	-0.018	-0.030	-0.048	-0.075	-0.120
6	10	-0.015	-0.022	-0.036	-0.058	-0.090	-0.150
10	18	-0.018	-0.027	-0.043	-0.070	-0.110	-0.180
18	30	-0.021	-0.033	-0.052	-0.084	-0.130	-0.210
30	50	-0.025	-0.039	-0.062	-0.100	-0.160	-0.250
50	80	-0.030	-0.046	-0.074	-0.120	-0.190	-0.300
80	120	-0.035	-0.054	-0.087	-0.140	-0.220	-0.350
120	180	-0.040	-0.063	-0.100	-0.160	-0.250	-0.400
180	250	-0.046	-0.072	-0.115	-0.185	-0.290	-0.460



OBLONGOS

OBLONGO

Dimensão Externa	Espessura (mm) Peso Kg / 6.000 mm															
	0,75	0,90	0,95 Zn	1,06	1,20	1,25 Zn	1,50	1,55 Zn	1,90	1,95 Zn	2,00	2,25	2,65	3,00	3,35	3,75
A x B (mm)																
14 x 22	2,031	2,417	2,544	2,822	3,169	3,292	3,895									
16 x 30	2,736	3,263	3,437	3,818	4,297	4,467	5,305	5,470	6,607	6,766	6,925	7,707	8,921	9,944	10,930	12,013
18 x 43		4,531	4,775	5,311	5,987	6,228	7,418	7,653	9,283	9,513	9,742	10,877				
20 x 35		3,875	4,084	4,539	5,114	5,318	6,326	6,525	7,900							
20 x 48		4,954	5,222	5,810	6,552	6,816	8,123	8,383	10,177	10,431	10,683	11,936	13,901			
20 x 58		5,800	6,115	6,806	7,680	7,990	9,533	9,839	11,963	12,263	12,563	14,050	16,391			
22,2 x 37,5		4,108	4,330	4,814	5,425	5,641	6,714	6,926	8,392	8,598	8,804					
29 x 58		6,219	6,558	7,300	8,239	8,543	10,232	10,562	12,848	13,172	13,495	15,098	17,626	19,798		
30 x 90							15,204	15,699	19,146	19,635	20,124	22,556	26,409	29,742		
40 x 77				9,794	11,062	11,514	13,761	14,208	17,318	17,760	18,200	20,392	23,860	26,856	29,816	33,154
50 x 98							17,645	18,222	22,238	22,809	23,379	26,218	30,722	34,625	38,491	42,865
50 x 150							25,036	25,859	31,600	32,417	33,234	37,305	43,780	49,407	54,997	61,342







SEMI-OBLONGO

Dimensão Externa	Espessura (mm) Peso Kg / 6.000 mm									
	0,90	0,95 Zn	1,06	1,20	1,25 Zn	1,50	1,55 Zn	1,90	1,95 Zn	2,00
A x B (mm)										
20 x 54	5,800	6,115	6,806	7,680	7,990	9,553	9,839	11,963	12,263	12,563
20 x 59	6,219	6,558	7,300	8,239	8,573	10,232	10,562	12,848	13,172	13,495
25 x 60	6,645	7,007	7,802	8,807	9,165	10,942	11,296	13,748	14,095	14,442

SEMI-OBLONGO COM ABA

Dimensão Externa		Espessura (mm) Peso Kg / 6.000 mm			
A x B (mm)	C (mm)	0,90	0,95 Zn	1,06	1,20
20 x 50	34,5	6,645	7,007	7,802	8,807
20 x 55	40,0	7,491	7,900	8,798	9,935

PESO DE AÇO EM BARRAS (kgs/mt)

Diam. Pol.	mm				Diam. Pol.	mm			Diam. Pol.	mm		
3/16	4,76	0,15	0,18	0,17	2.5/16	58,73	21,25	27,06	6.1/2	165,10	167,93	213,50
1/4	6,35	0,25	0,32	0,27	2.3/8	60,33	22,42	28,54	6.3/4	171,45	181,15	231,05
5/16	7,93	0,39	0,49	0,43	2.7/16	61,91	23,61	30,06	7	177,80	194,72	248,15
3/8	9,53	0,56	0,71	0,62	2.1/2	63,50	24,84	31,62	7.1/4	184,15	209,75	266,21
7/16	11,11	0,76	0,97	0,84	2.9/16	65,08	26,10	33,22	7.1/2	190,50	223,82	285,00
1/2	12,70	0,99	1,27	1,10	2.5/8	66,68	27,38	34,87	7.3/4	196,85	238,93	304,00
9/16	14,28	1,26	1,60	1,39	2.11/16	68,26	28,70	36,55	8	203,20	254,60	324,05
5/8	15,88	1,55	1,98	1,71	2.3/4	69,85	30,05	38,27	8.1/4	209,55	270,74	345,01
11/16	17,46	1,88	2,39	2,07	2.13/16	71,44	31,44	40,02	8.1/2	215,90	287,45	365,92
3/4	19,05	2,24	2,85	2,46	2.7/8	73,02	32,85	41,82	8.3/4	222,25	304,63	388,53
13/16	20,64	2,62	3,34	2,89	2.15/16	74,61	34,29	43,66	9	228,60	322,11	410,22
7/8	22,22	3,04	3,87	3,35	3	76,20	35,77	45,54	9.1/4	234,95	340,38	433,56
15/16	23,81	3,49	4,45	3,85	3.1/8	79,38	38,81	49,41	9.1/2	241,30	359,00	457,17
1	25,40	3,97	5,06	4,38	3.1/4	82,55	41,88	53,44	9.3/4	247,65	378,16	481,44
1.1/16	26,98	4,49	5,71	4,95	3.3/8	85,73	45,27	57,63	10	254,00	397,87	506,53
1.1/8	28,58	5,03	6,40	5,55	3.1/2	88,90	48,68	61,98	10.1/4	260,35	417,97	532,01
1.3/16	30,16	5,60	7,14	6,18	3.5/8	92,08	52,22	66,49	10.1/2	266,70	438,58	558,44
1.1/4	31,75	6,21	7,91	6,85	3.3/4	95,25	55,88	71,15	10.3/4	273,05	459,72	585,38
1.5/16	33,33	6,85	8,72	7,55	3.7/8	98,42	60,67	75,98	11	279,40	481,23	612,87
1.3/8	34,93	7,51	9,57	8,29	4	101,60	63,58	80,96	11.1/4	285,75	503,47	641,02
1.7/16	36,51	8,21	10,45	9,06	4.1/8	104,78	67,52	86,10	11.1/2	292,10	526,05	669,81
1.1/2	38,10	8,94	11,39	9,86	4.1/4	107,95	71,78	91,39	11.3/4	298,45	549,11	699,22
1.9/16	39,68	9,70	12,35	10,70	4.3/8	111,13	76,06	96,85	12	304,80	572,74	729,35
1.5/8	41,28	10,49	13,36	11,57	4.1/2	114,30	80,47	102,46	13	330,20	672,65	855,83
1.11/16	42,86	11,32	14,41	12,48	4.5/8	117,48	85,01	108,23	14	355,60	779,74	992,62
1.3/4	44,45	12,17	15,50	13,42	4.3/4	120,65	89,66	114,16	15	381,00	894,92	1.139,50
1.13/16	46,04	13,06	16,62	14,40	4.7/8	123,82	94,44	120,25	16	406,40	1.017,30	1.304,70
1.7/8	47,62	13,97	17,79	15,41	5	127,00	99,80	126,51	17	431,80	1.148,50	1.462,30
2	50,80	15,90	20,24	17,53	5.1/4	133,35	109,5	139,52	18	457,20	1.287,60	1.639,40
2.1/16	52,39	16,91	21,52	18,64	5.1/2	139,70	120,2	153,12	19	482,60	1.445,00	1.839,00
2.1/8	53,98	17,95	22,85	19,79	5.3/4	146,05	131,4	167,23	20	508,00	1.589,50	2.023,90
2.3/16	55,56	19,02	24,21	20,97	6	152,40	143,1	182,54	22	558,80	1.924,00	2.498,10
2.1/4	57,15	20,12	25,62	22,19	6.1/4	158,75	155,2	197,86	24	609,60	2.284,80	2.972,90



BARRAS

CHATAS

BARRA CHATA

Espessura		Largura										Peso por metro - Kg/m			
Pol.	(mm)	1/2" (12,70)	5/8" (15,88)	3/4" (19,05)	7/8" (22,23)	1" (25,40)	1.1/4" (31,75)	1.1/2" (38,10)	2" (50,80)	2.1/2" (63,50)	3" (76,20)	3.1/2"	4" (101,60)	5" (127,00)	6" (152,40)
1/8"	(3,17)	0,32	0,40	0,47	0,55	0,63	0,79	0,95	1,27	1,58	1,90		2,54	3,17	3,79
3/16"	(4,76)	0,47	0,59	0,71	0,83	0,95	1,19	1,43	1,90	2,37	2,85		3,80	4,78	5,69
1/4"	(6,35)	0,63	0,79	0,95	1,11	1,27	1,58	1,90	2,53	3,16	3,80	4,42	5,06	6,33	7,59
5/16"	(7,93)					1,58	1,98	2,37	3,17	3,95	4,75	5,53	6,33	7,91	9,49
3/8"	(9,52)					1,90	2,37	2,85	3,80	4,74	5,70	6,65	7,59	9,50	11,39
1/2"	(12,70)					2,53	3,16	3,79	5,06	6,33	7,60	8,85	10,12	12,66	15,18
5/8"	(15,88)					3,16	3,95	4,74	6,33	7,91	9,49	11,07	12,65	15,82	18,94
3/4"	(19,05)					3,80	4,75	5,70	7,59	9,49	11,39	13,28	15,18	18,97	22,77
1"	(25,40)							7,59	10,12	12,65	15,18	17,70	20,24	25,30	30,36



CANTONEIRAS

bf	tf	Peso Nominal	bf	tf	Área	Jx=Jy	Wx=Wy	rx=ry	rz mín.	x
pol.	pol.	Kg/m	mm	mm	cm ²	cm ⁴	cm ³	cm	cm	cm
1/2"	1/8"	0,55	12,700	3,17	0,70	0,10	0,11	0,37	0,25	0,43
5/8"	1/8"	0,71	15,880	3,17	0,90	0,20	0,19	0,47	0,32	0,51
3/4"	1/8"	0,87	19,050	3,17	1,11	0,36	0,27	0,57	0,38	0,59
7/8"	1/8"	1,04	22,200	3,17	1,32	0,58	0,38	0,66	0,46	0,66
	1/8"	1,19	25,400	3,17	1,48	0,83	0,49	0,79	0,48	0,76
1"	3/16"	1,73	25,400	4,76	2,19	1,25	0,66	0,76	0,48	0,81
	1/4"	2,22	25,400	6,35	2,84	1,66	0,98	0,76	0,48	0,86
	1/8"	1,50	31,750	3,17	1,93	1,67	0,82	0,97	0,64	0,89
1.1/4"	3/16"	2,20	31,750	4,76	2,77	2,50	1,15	0,97	0,61	0,97
	1/4"	2,86	31,750	6,35	3,62	3,33	1,47	0,94	0,61	1,02
	1/8"	1,83	38,100	3,17	2,32	3,33	1,15	1,17	0,76	1,07
1.1/2"	3/16"	2,68	38,100	4,76	3,42	4,58	1,64	1,17	0,74	1,12
	1/4"	3,48	38,100	6,35	4,45	5,83	2,13	1,15	0,74	1,19
	1/8"	2,14	44,450	3,17	2,71	5,41	1,64	1,40	0,89	1,22
1.3/4"	3/16"	3,15	44,450	4,76	4,00	7,50	2,30	1,37	0,89	1,30
	1/4"	4,12	44,450	6,35	5,22	9,57	3,13	1,35	0,86	1,35
	1/8"	2,46	50,800	3,17	3,10	7,91	2,13	1,60	1,02	1,40
	3/16"	3,63	50,800	4,76	4,58	11,70	3,13	1,58	1,02	1,45
2"	1/4"	4,74	50,800	6,35	6,06	14,60	4,10	1,55	0,99	1,50
	5/16"	5,83	50,800	7,94	7,42	17,50	4,91	1,53	0,99	1,55
	3/8"	6,99	50,800	9,52	8,76	20,00	5,73	1,50	0,99	1,63
	3/16"	4,57	63,500	4,76	5,80	23,00	4,91	1,98	1,24	1,75
	1/4"	6,10	63,500	6,35	7,67	29,00	6,40	1,96	1,24	1,83
2.1/2"	5/16"	7,44	63,500	7,94	9,48	35,00	7,87	1,93	1,24	1,88
	3/8"	8,78	63,500	9,52	11,16	41,00	9,35	1,91	1,22	1,93
	3/16"	5,52	76,200	4,76	7,03	40,00	7,21	2,39	1,50	2,08
	1/4"	7,29	76,200	6,35	9,29	50,00	9,50	2,36	1,50	2,13
3"	5/16"	9,07	76,200	7,94	11,48	62,00	11,60	2,34	1,50	2,21
	3/8"	10,71	76,200	9,52	13,61	75,00	13,60	2,31	1,47	2,26
	1/2"	14,00	76,200	12,70	17,74	91,00	18,00	2,29	1,47	2,36
	1/4"	8,56	88,900	6,35	10,90	83,70	13,00	2,77	1,76	2,46
3.1/2"	5/16"	10,59	88,900	7,94	13,50	102,00	16,00	2,75	1,75	2,52
	3/8"	12,58	88,900	9,52	16,00	121,00	19,20	2,75	1,75	2,58
	1/4"	9,81	101,600	4,76	12,51	125,00	16,40	3,17	2,00	2,77
	5/16"	12,19	101,600	6,35	15,48	154,00	21,30	3,15	2,00	2,84
4"	3/8"	14,57	101,600	7,94	18,45	183,00	24,60	3,12	2,00	2,90
	7/16"	16,80	101,600	9,52	21,35	208,00	29,50	3,12	1,98	2,95
	1/2"	19,03	101,600	12,70	24,19	233,00	32,80	3,10	1,98	3,00
	1/4"	12,34	127,000	6,35	15,73	251,63	27,09	4,00	2,53	3,41
	5/16"	15,31	127,000	7,94	19,50	308,00	33,40	3,97	2,53	3,47
	3/8"	18,30	127,000	9,52	23,29	362,00	39,50	3,94	2,51	3,53
5"	1/2"	24,10	127,000	12,70	30,64	470,00	52,50	3,91	2,49	3,63
	5/8"	29,80	127,000	15,88	37,80	566,00	64,00	3,86	2,46	3,76
	7/16"	23,52	127,000	11,11	26,96	416,68	45,71	3,93	2,50	3,58
	3/8"	22,20	152,400	9,52	28,10	641,00	57,40	4,78	3,02	4,17
6"	1/2"	29,20	152,400	12,70	37,09	828,00	75,40	4,72	3,00	4,27
	5/8"	36,00	152,400	15,88	45,86	1007,00	93,50	4,67	2,97	4,39
	3/4"	42,70	152,400	19,05	54,44	1173,00	109,90	4,65	2,97	4,52
8"	5/8"	48,70	203,200	15,88	62,90	2472,40	168,90	6,31	4,01	5,66
	3/4"	57,90	203,200	19,05	73,81	2901,10	199,90	6,27	3,99	5,79



VIGAS "U"

Tamanho Nominal		Altura (A)		Peso		Largura das Abas (B)		Espessura da Alma (C)	
mm	pol.	mm	pol.	Kg/m	lb/pé	mm	pol.	mm	pol.
76,20 x 38,10	3 x 1.1/2	76,20	3	6,10	4,10	35,81	1,410	4,32	0,170
				7,44	5,00	38,05	1,498	6,55	0,258
				8,93	6,00	40,54	1,596	9,04	0,356
101,60 x 41,28	4 x 1.5/8	101,60	4	8,04	5,40	40,13	1,580	4,57	0,180
				9,30	6,25	41,83	1,647	6,27	0,247
				10,79	7,25	43,69	1,720	8,13	0,320
152,40 x 50,80	6 x 2	152,40	6	12,20	8,20	48,77	1,920	5,08	0,200
				15,63	10,50	51,66	2,034	7,98	0,314
				19,35	13,00	54,79	2,157	11,10	0,437
				23,07	15,50	57,89	2,279	14,20	0,559
203,20 x 57,15	8 x 2.1/4	203,20	8	17,11	11,50	57,40	2,260	5,59	0,220
				20,46	13,75	59,51	2,343	7,70	0,303
				24,18	16,25	61,85	2,435	10,03	0,395
				27,90	18,75	64,19	2,527	12,37	0,487
				31,62	21,25	66,52	2,619	14,71	0,579
254,00 x 66,68	10 x 2.5/8	254,00	10	22,77	15,3	66,04	2,600	6,10	0,240
				29,76	20,0	69,57	2,739	9,63	0,379
				37,20	25,0	73,30	2,886	13,36	0,526
				44,65	30,0	77,04	3,033	17,09	0,673
				52,09	35,0	80,77	3,180	20,83	0,820
304,80 x 85,73	12 x 3	304,80	12	30,81	20,7	74,68	2,940	7,11	0,280
				37,20	25,0	77,39	3,047	9,83	0,387
				44,65	30,0	80,52	3,170	12,95	0,510
				52,09	35,0	83,62	3,292	16,05	0,632
				59,53	40,0	86,74	3,415	19,18	0,755
381,00 x 85,73	15 x 3.3/8	381,00	15	50,45	33,9	86,36	3,400	10,16	0,400
				52,09	35,0	86,92	3,422	10,72	0,422
				59,53	40,0	89,41	3,520	13,21	0,520
				66,97	45,0	91,90	3,618	15,70	0,618
				74,41	50,0	94,39	3,716	18,19	0,716
				81,85	55,0	96,88	3,814	20,68	0,814

OBS: Todos os pesos e dimensões constantes destas tabelas são nominais, podendo ter diferenças de acordo com as tolerâncias estabelecidas nas especificações ou em norma. As barras são fornecidas com tolerância de -0,0 m, +0,1 m.

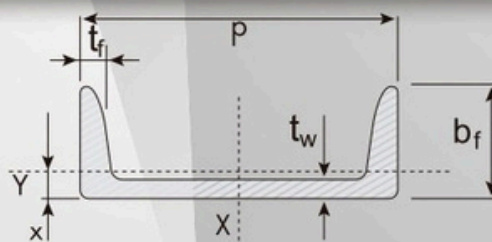

PERFIL "U"

PERFIL "U" SIMPLES UDC (DOBRADO DE CHAPA)			
Dimensões			P
h	B	e = r	P
mm	mm	mm	kg/m
45	17	1,80	1,01
		2,00	1,11
		2,25	1,24
		2,65	1,42
		3,00	1,58
50	25	1,80	1,31
		2,00	1,44
		2,25	1,61
		2,65	1,86
		3,00	2,07
68	30	1,80	1,71
		2,00	1,88
		2,25	2,10
		2,65	2,44
		3,00	2,73
75	40	1,80	2,09
		2,00	2,31
		2,25	2,58
		2,65	3,00
		3,00	3,37
		3,35	3,72
		3,75	4,12
4,25	4,60		
92	30	1,80	2,05
		2,00	2,26
		2,25	2,53
		2,65	2,94
		3,00	3,30
92	40	1,80	2,33
		2,00	2,57
		2,25	2,88
		2,65	3,36
		3,00	3,77
100	40	1,80	2,44
		2,00	2,70
		2,25	3,02
		2,65	3,52
		3,00	3,96
		3,35	4,38
		3,75	4,86
100	50	4,25	5,44
		4,75	6,00
		1,80	2,72
		2,00	3,01
		2,25	3,37
		2,65	3,94
		3,00	4,43
3,35	4,91		
3,75	5,45		
4,25	6,11		
4,75	6,75		

Dimensões			P
h	B	e = r	P
mm	mm	mm	kg/m
127	50	1,80	3,11
		2,00	3,44
		2,25	3,85
		2,65	4,50
		3,00	5,06
		3,35	5,62
		3,75	6,24
		4,25	7,01
		4,75	7,76

OBS: OS VALORES DOS PESOS SÃO APROXIMADO

PERFIL "U" SIMPLES UDC (DOBRADO DE CHAPA)			
Dimensões			P
h	B	e = r	P
mm	mm	mm	kg/m
150	50	1,80	3,43
		2,00	3,80
		2,25	4,26
		2,65	4,98
		3,00	5,60
		3,35	6,22
		3,75	6,92
		4,25	7,77
		4,75	8,61
		200	50
2,00	4,58		
2,25	5,14		
2,65	6,02		
3,00	6,78		
3,35	7,54		
3,75	8,39		
4,25	9,44		
4,75	10,48		



PERFIL "U" ENRIJECIDOS
UDC (DOBRADO DE CHAPA)

Dimensões				P
h	B	d	e = r	kg/m
mm	mm	mm	mm	
50	25	10	1,80	1,49
			2,00	1,63
			2,25	1,80
			2,65	2,06
			3,00	2,26
75	40	15	1,80	2,41
			2,00	2,65
			2,25	2,95
			2,65	3,41
			3,00	3,79
100	50	17	1,80	3,10
			2,00	3,42
			2,25	3,82
			2,65	4,43
			3,00	4,95
127	50	17	1,80	3,48
			2,00	3,85
			2,25	4,29
			2,65	4,99
			3,00	5,58
150	60	20	1,80	4,18
			2,00	4,62
			2,25	5,16
			2,65	6,01
			3,00	6,74
			3,35	7,45
			3,75	8,24
200	60	20	4,25	9,21
			4,75	10,14
			1,80	4,88
			2,00	5,40
			2,25	6,04
200	75	25	2,65	7,05
			3,00	7,91
			3,35	8,85
			3,75	9,81
			4,25	10,89
			4,75	12,21
			1,80	13,50
210	30	15	1,80	4,04
			2,00	4,49

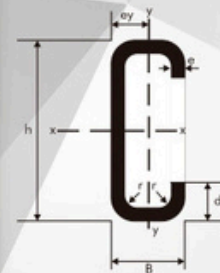

S = área de seção
P = peso estimado por metro
Jx = momento da inércia do eixo x
Wx = módulo de resistência do eixo x
ix = raio de giro do eixo x

ey = distância da linha neutra
Jy = momento da inércia do eixo y
Wy = módulo de resistência do eixo y
iy = raio de giro do eixo y

VIGAS “I”

Tamanho Nominal		Altura (A)		Peso		Largura das Abas (B)		Espessura da Alma (C)	
mm	pol.	mm	pol.	Kg/m	lb/pé	mm	pol.	mm	pol.
76,20 x 60,33	3 x 2 3/8	76,20	3	8,48	5,7	59,18	2,330	4,32	0,170
				9,67	6,5	61,24	2,411	6,38	0,251
				11,16	7,5	63,73	2,509	8,86	0,349
101,60 x 66,68	4 x 2 5/8	101,60	4	11,46	7,7	67,56	2,660	4,83	0,190
				12,65	8,5	69,16	2,723	6,43	0,253
				14,14	9,5	71,02	2,796	8,28	0,326
				15,63	10,5	72,90	2,870	10,16	0,400
127,00 x 76,20	5 x 3	127,00	5	14,88	10,0	76,20	3,000	5,33	0,210
				18,23	12,25	79,68	3,137	8,81	0,347
				21,95	14,75	83,41	3,284	12,55	0,494
152,40 x 85,73	6 x 3 3/8	152,40	6	18,60	12,5	84,58	3,330	5,84	0,230
				21,95	14,75	87,45	3,443	8,71	0,343
				25,67	17,25	90,55	3,565	11,81	0,465

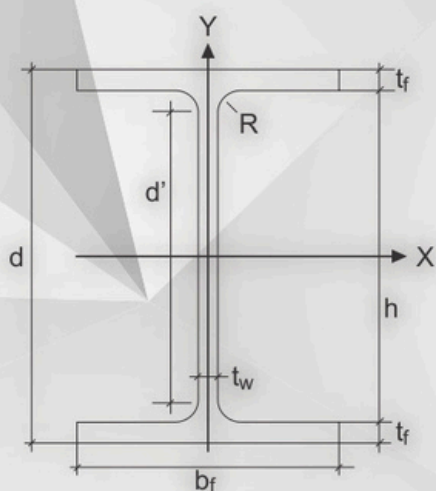

- d = altura do perfil
- d' = altura livre da alma
- h = altura interna
- bf = largura da aba do perfil
- tf = espessura da aba
- tw = espessura da alma
- R = raio de concordância

PERFIS “I”

BITOLA	linear kg/m	d mm	bf mm	d' mm	h mm	tw mm	tf mm	lx cm4	Wx cm3	rx cm	ly cm4	Wy cm3	ry cm	A cm2
W 150 x 13,0	13,0	148	100	118	138	4,3	4,9	635	085,8	6,18	82	16,4	2,22	16,6
W 150 x 18,0	18,0	153	102	119	139	5,8	7,1	939	122,8	6,34	126	24,7	2,32	23,4
W 150 x 24,0	24,0	160	102	115	139	6,6	10,3	1.384	173,0	6,63	183	35,9	2,41	31,5
W 200 x 15,0	15,0	200	100	170	190	4,3	5,2	1.305	130,5	8,20	87	17,4	2,12	19,4
W 200 x 19,3	19,3	203	102	170	190	5,8	6,5	1.686	166,1	8,19	116	22,7	2,14	25,1
W 200 x 22,5	22,5	206	102	170	190	6,2	8,0	2.029	197,0	8,37	142	27,9	2,22	29,0
W 200 x 26,6	26,6	207	133	170	190	5,8	8,4	2.611	252,3	8,73	330	49,6	3,10	34,2
W 200 x 31,3	31,3	210	134	170	190	6,4	10,2	3.168	301,7	8,86	410	61,2	3,19	40,3
W 250 x 17,9	17,9	251	101	220	240	4,8	5,3	2.291	182,6	9,96	91	18,1	1,99	23,1
W 250 x 22,3	22,3	254	102	220	240	5,8	6,9	2.939	231,4	10,09	123	24,1	2,06	28,9
W 250 x 25,3	25,3	257	102	220	240	6,1	8,4	3.473	270,2	10,31	149	29,3	2,14	32,6
W 250 x 28,4	28,4	260	102	220	240	6,4	10,0	4.046	311,2	10,51	178	34,8	2,20	36,6
W 250 x 32,7	32,7	258	146	220	240	6,1	9,1	4.937	382,7	10,83	473	64,8	3,35	42,1
W 250 x 38,5	38,5	262	147	220	240	6,6	11,2	6.057	462,4	11,05	594	80,8	3,46	49,6
W 250 x 44,8	44,8	266	148	220	240	7,6	13,0	7.158	538,2	11,15	704	95,1	3,50	57,6
W 310 x 21,0	21,0	303	101	272	292	5,1	5,7	3.776	249,2	11,77	98	19,5	1,90	27,2
W 310 x 23,8	23,8	305	101	272	292	5,6	6,7	4.346	285,0	11,89	116	22,9	1,94	30,7
W 310 x 28,3	28,3	309	102	271	291	6,0	8,9	5.500	356,0	12,28	158	31,0	2,08	36,5
W 310 x 32,7	32,7	313	102	271	291	6,6	10,8	6.570	419,8	12,49	192	37,6	2,13	42,1
W 310 x 38,7	38,7	310	165	271	291	5,8	9,7	8.581	553,6	13,14	727	88,1	3,82	49,7
W 310 x 44,5	44,5	313	166	271	291	6,6	11,2	9.997	638,8	13,22	855	103,0	3,87	57,2
W 310 x 52,0	52,0	317	167	271	291	7,6	13,2	11.909	751,4	13,33	1.026	122,9	3,91	67,0
W 360 x 32,9	32,9	349	127	308	332	5,8	8,5	8.358	479,0	14,09	291	45,9	2,63	42,1
W 360 x 39,0	39,0	353	128	308	332	6,5	10,7	10.331	585,3	14,35	375	58,6	2,73	50,2
W 360 x 44,0	44,0	352	171	308	332	6,9	9,8	12.258	696,5	14,58	818	95,7	3,77	57,7
W 360 x 51,0	51,0	355	171	308	332	7,2	11,6	14.222	801,2	14,81	968	113,3	3,87	64,8
W 360 x 57,8	57,8	358	172	308	332	7,9	13,1	16.143	901,8	14,92	1.113	129,4	3,92	72,5
W 360 x 64,0	64,0	347	203	288	320	7,7	13,5	17.890	1.031,1	14,80	1.885	185,7	4,80	81,7
W 360 x 72,0	72,0	350	204	288	320	8,6	15,1	20.169	1.152,5	14,86	2.140	209,8	4,84	91,3
W 360 x 79,0	79,0	354	205	288	320	9,4	16,8	22.713	1.283,2	14,98	2.416	235,7	4,89	101,2
W 410 x 38,8	38,8	399	140	357	381	6,4	8,8	12.777	640,5	15,94	404	57,7	2,83	50,3
W 410 x 46,1	46,1	403	140	357	381	7,0	11,2	15.690	778,7	16,27	514	73,4	2,95	59,2
W 410 x 53,0	53,0	403	177	357	381	7,5	10,9	18.734	929,7	16,55	1.009	114,0	3,84	68,4
W 410 x 60,0	60,0	407	178	357	381	7,7	12,8	21.707	1.066,7	16,88	1.205	135,4	3,98	76,2
W 410 x 67,0	67,0	410	179	357	381	8,8	14,4	24.678	1.203,8	16,91	1.379	154,1	4,00	86,3
W 410 x 75,0	75,0	413	180	357	381	9,7	16,0	27.616	1.337,3	16,98	1.559	173,2	4,03	95,8
W 410 x 85,0	85,0	417	181	357	381	10,9	18,2	31.658	1.518,4	17,07	1.804	199,3	4,08	108,6
W 460 x 52,0	52,0	450	152	404	428	7,6	10,8	21.370	949,8	17,91	634	83,5	3,09	66,6
W 460 x 60,0	60,0	455	153	404	428	8,0	13,3	25.652	1.127,6	18,35	796	104,1	3,23	76,2
W 460 x 68,0	68,0	459	154	404	428	9,1	15,4	29.851	1.300,7	18,46	941	122,2	3,28	87,6
W 460 x 74,0	74,0	457	190	404	428	9,0	14,5	33.415	1.462,4	18,77	1.661	174,8	4,18	94,9
W 460 x 82,0	82,0	460	191	404	428	9,9	16,0	37.157	1.615,5	18,84	1.862	195,0	4,22	104,7
W 460 x 89,0	89,0	463	192	404	428	10,5	17,7	41.105	1.775,6	18,98	2.093	218,0	4,28	114,1
W 460 x 97,0	97,0	466	193	404	428	11,4	19,0	44.658	1.916,7	19,03	2.283	236,6	4,30	123,4
W 460 x 106,0	106,0	469	194	404	428	12,6	20,6	48.978	2.088,6	19,04	2.515	259,3	4,32	135,1
W 530 x 66,0	66,0	525	165	478	502	8,9	11,4	34.971	1.332,2	20,46	857	103,9	3,20	83,6
W 530 x 72,0	72,0	524	207	478	502	9,0	10,9	39.969	1.525,5	20,89	1.615	156,0	4,20	91,6
W 530 x 74,0	74,0	529	166	478	502	9,7	13,6	40.969	1.548,9	20,76	1.041	125,5	3,31	95,1
W 530 x 82,0	82,0	528	209	477	501	9,5	13,3	47.569	1.801,8	21,34	2.028	194,1	4,41	104,5
W 530 x 85,0	85,0	535	166	478	502	10,3	16,5	48.453	1.811,3	21,21	1.263	152,2	3,42	107,7
W 530 x 92,0	92,0	533	209	478	502	10,2	15,6	55.157	2.069,7	21,65	2.379	227,6	4,50	117,6
W 530 x 101,0	101,0	537	210	470	502	10,9	17,4	62.198	2.316,5	21,87	2.693	256,5	4,55	130,0
W 530 x 109,0	109,0	539	211	469	501	11,6	18,8	67.226	2.494,5	21,94	2.952	279,8	4,60	139,7
W 610 x 101,0	101,0	603	228	541	573	10,5	14,9	77.003	2.554,0	24,31	2.951	258,8	4,76	130,3
W 610 x 113,0	113,0	608	228	541	573	11,2	17,3	88.196	2.901,2	24,64	3.426	300,5	4,86	145,3
W 610 x 125,0	125,0	612	229	541	573	11,9	19,6	99.184	3.241,3	24,89	3.933	343,5	4,96	160,1
W 610 x 140,0	140,0	617	230	541	573	13,1	22,2	112.619	3.650,5	25,06	4.515	392,6	5,02	179,3
W 610 x 155,0	155,0	611	324	541	573	12,7	19	129.583	4.241,7	25,58	10.783	665,6	7,38	198,1
W 610 x 174,0	174,0	616	325	541	573	14,0	21,6	147.754	4.797,2	25,75	12.374	761,5	7,45	222,8

PERFIL “T”

PERFIL “T”

Bitola	Peso Nominal Kg/m	Altura h=bf mm	Espessura e mm	Área cm ²	Eixo X			Eixo Y			
					J	W	r	J	W	r	x
					cm ⁴	cm ³	cm	cm ⁴	cm ³	cm	cm
5/8x1/8"	0,71	15,88	3,18	0,90	0,20	0,19	0,47	0,11	0,14	0,35	0,51
3/4x1/8"	0,86	19,05	3,18	1,13	0,36	0,27	0,57	0,19	0,20	0,41	0,59
7/8x1/8"	0,99	22,22	3,18	1,34	0,59	0,38	0,67	0,33	0,27	0,48	0,67
1x1/8"	1,18	25,40	3,18	1,54	0,90	0,50	0,77	0,44	0,35	0,54	0,75
1.1/4x1/8"	1,50	31,75	3,18	1,92	1,84	0,81	0,98	0,86	0,54	0,67	0,91
1.1/2x1/8"	1,82	38,10	3,18	2,32	3,24	1,18	1,18	1,47	0,77	0,80	1,07
1.1/4x3/16"	2,16	31,75	4,76	2,79	2,56	1,16	0,96	1,29	0,82	0,68	0,97
1.1/2x3/16"	2,65	38,10	4,76	3,40	4,56	1,70	1,16	2,22	1,17	0,81	1,13
2x3/16"	3,62	50,80	4,76	4,61	11,33	3,12	1,57	5,24	2,06	1,07	1,45
2x1/4"	4,74	50,80	6,35	6,05	14,47	4,04	1,55	7,03	2,77	1,08	1,50



TABELA DE EQUIVALÊNCIA PERFIS "I" VIGAS

PERFIS LAMINADOS			PERFIS SOLDADOS	
ABAS PARALELAS		ABAS INCLINADAS	ELETRO-SOLDADOS	
mm x Kg/m	pol. x lb/ft	pol. x Kg/m	mm x Kg/m	mm x Kg/m
W 150 X 13,0	W 6 X 8,5		VE 150 X 13	VS 150 X 15
W 150 X 18,0	W 6 X 12	I 6 X 18,6 / I 6 X 22,0	VE 150 X 18	VS 150 X 18 / VS 150 X 19 / VS 150 X 20 / VS 150 X 21
W 200 X 16,0	W 8 X 10	I 6 X 18,6 / I 6 X 22,0	VE 200 X 16	VS 200 X 17
W 200 X 19,3	W 8 X 13	I 6 X 22,0	VE 200 X 16	VS 200 X 19 / VS 200 X 20 / VS 200 X 21
W 200 X 22,5	W 8 X 15	I 8 X 27,4	VE 200X16 / CVE 200X200 / CE 200X22	VS 200 X 22 / VS 200 X 23 / VS 200 X 24
W 200 X 26,6	W 8 X 18	I 8 X 27,4 / I 8 X 30,5	CVE 200 X 28	VS 200 X 25 / VS 200 X 26 / VS 200 X 27 / VS 200 X 28
W 200 X 31,3	W 8 X 21			VS 200 X 30
W 250 X 17,9	W 10 X 12		VE 250 X 18	
W 250 X 22,3	W 10 X 15	I 8 X 27,4 / I 8 X 30,5	VE 250 X 18	VS 250 X 21 / VS 250 X 23
W 250 X 25,3	W 10 X 17	I 8 X 27,4 / I 8 X 30,5	VE 250 X 27	VS 250 X 24 / VS 250 X 25 / VS 250 X 26 / VS 250 X 27
W 250 X 28,4	W 10 X 19	I 8 X 30,5	VE 250 X 27	VS 250 X 28 / VS 250 X 29 / VS 250 X 30 / VS 250 X 31
W 250 X 32,7	W 10 X 22	I 10 X 37,7	CVE 250 X 31	VS 250 X 32 / VS 250 X 33 / VS 250 X 35 / VS 250 X 37 / VS 250 X 38
W 250 X 38,5	W 10 X 26	I 10 X 37,7 / I 10 X 44,7	CVW 250 X 38	
W 250 X 44,8	W 10 X 30			
W 310 X 21,0	W 12 X 14			
W 310 X 23,8	W 12 X 16		VE 300 X 26	VS 300 X 23 / VS 300 X 25
W 310 X 28,3	W 12 X 19	I 10 X 37,7	VE 300 X 26	VS 300 X 26 / VS 300 X 27 / VS 300 X 28 / VS 300 X 29
W 310 X 32,7	W 12 X 22	I 10 X 37,7 / I 10 X 44,7	VE 300 X 33	VS 300 X 31 / VS 300 X 32 / VS 300 X 33 / VS 300 X 34 / VS 300 X 36
W 310 X 38,7	W 12 X 26	I 10 X 37,7 / I 10 X 44,7		VS 300 X 37 / VS 300 X 38 / VS 300 X 41 / VS 300 X 43
W 310 X 44,5	W 12 X 30	I 12 X 60,7		VS 300 X 46
W 310 X 52,0	W 12 X 35	I 12 X 60,7 / I 12 X 67,0	VEE 315 X 51	VS 300 X 61
W 360 X 32,9	W 14 X 22		VE 350 X 35	VS 350 X 30 / VS 350 X 31 / VS 350 X 33 / VS 350 X 34
W 360 X 39,0	W 14 X 26		VE 350 X 35	VS 350 X 36 / VS 350 X 38 / VS 350 X 39
W 360 X 44,0	W 14 X 30	I 12 X 60,7 / I 12 X 67,0	VE 350 X 43	VS 350 X 42 / VS 350 X 46
W 360 X 51,0	W 14 X 34	I 12 X 60,7 / I 12 X 67,0		VS 350 X 49 / VS 350 X 51
W 360 X 57,8	W 14 X 38	I 12 X 60,7 / I 12 X 67,0	CVE 350 X 58	VS 350 X 58
W 360 X 64,0	W 14 X 43			
W 360 X 72,0	W 14 X 48			
W 360 X 79,0	W 14 X 53			
W 410 X 38,8	W 16 X 26		VE 400 X 44	VS 400 X 37 / VS 400 X 38
W 410 X 46,1	W 16 X 31		VE 400 X 44	VS 400 X 44
W 410 X 53,0	W 16 X 36		VE 400 X 49	VS 400 X 49 / VS 400 X 53
W 410 X 60,0	W 16 X 40			VS 400 X 58
W 410 X 67,0	W 16 X 45			VS 400 X 68
W 410 X 75,0	W 16 X 50			VS 400 X 78
W 460 X 52,0	W 18 X 35		VE 450 X 51	VS 450 X 51
W 460 X 60,0	W 18 X 40		VE 450 X 59	VS 450 X 59 / VS 450 X 60
W 460 X 68,0	W 18 X 46			

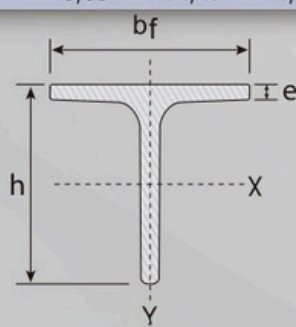

(CONTINUAÇÃO TABELA DE EQUIVALÊNCIA - PERFIS "I" - VIGAS

PERFIS LAMINADOS			PERFIS SOLDADOS	
ABAS PARALELAS		ABAS INCLINADAS	ELETRO-SOLDADOS	
mm x Kg/m	pol. x lb/ft	pol. x Kg/m	mm x Kg/m	
W 460 X 74,0	W 18 X 50		VS 450 X 70 / VS 450 X 71	
W 460 X 82,0	W 18 X 55		VS 450 X 80	
W 460 X 89,0	W 18 X 60		VS 450 X 83	
W 530 X 66,0	W 21 X 44	VE 500 X 61	VS 500 X 61	
W 530 X 72,0	W 21 X 48	VE 500 X 68	VS 500 X 73	
W 530 X 74,0	W 21 X 50	VE 500 X 73	VS 500 X 73	
W 530 X 82,0	W 21 X 55	VE 500 X 79	VS 550 X 75	
W 530 X 85,0	W 21 X 57		VS 500 X 86	
W 530 X 92,0	W 21 X 62		VS 500 X 97	
W 610 X 101,0	W 24 X 68		VS 550 X 100 / VS 600 X 95	
W 610 X 113,0	W 24 X 76		VS 600 X 111	
W 610 X 155,0	W 24 X 104		VS 600 X 152	
W 610 X 174,0	W 24 X 117			

TABELA DE EQUIVALÊNCIA
PERFIS "H" COLUNAS

PERFIS LAMINADOS			PERFIS SOLDADOS	
ABAS PARALELAS		ABAS INCLINADAS	ELETRO-SOLDADOS	
mm x Kg/m	pol. x lb/ft	pol. x Kg/m	mm x Kg/m	
W 150 X 22,5	W 6 X 15		CE 100 X 11	
W 150 X 29,8	W 6 X 20		CE 150 X 20	
W 150 X 37,1	W 6 X 25		CE 150 X 26	
W 200 X 35,9	W 8 X 24		CE 150 X 29 / CS 150 X 31	
W 200 X 46,1	W 8 X 31		CS 150 X 37 / CS 150 X 45	
HP 200 X 53,0	HP 8 X 36		CVS 200 X 34 / CVS 200 X 36 / CVS 200 X 37 / CVS 200 X 38	
HP 250 X 62,0	HP 10 X 42		CE 200 X 34 / CE 200 X 39	
W 250 X 73,0	W 10 X 49		CE 250 X 43	
W 250 X 80,0	W 10 X 54		CE 250 X 49	
HP 250 X 85,0	HP 10 X 57		CE 250 X 63	
W 250 X 89,0	W 10 X 60		CS 200 X 50 / CVS 200 X 46	
			CS 200 X 50 / CS 200 X 61	
			CS 250 X 63 / CS 250 X 66 / CVS 250 X 56 / CVS 250 X 64 / CVS 250 X 72	
			CS 250 X 76 / CS 250 X 79 / CVS 250 X 72	
			CS 250 X 79 / CS 250 X 84	
			CS 250 X 84	
			CS 250 X 90 / CS 250 X 95 / CS 250 X 108	
			CS 300 X 52	
			CS 300 X 62	
HP 310 X 79,0	HP 12 X 53		CS 300 X 62	
HP 310 X 93,0	HP 12 X 63		CS 300 X 76	
W 310 X 97,0	W 12 X 65		CS 300 X 76 / CVS 300 X 79 / CVS 300 X 80 / CVS 300 X 83 / CVS 300 X 85	
W 310 X 107,0	W 12 X 72		CS 300 X 95 / CVS 300 X 94 / CVS 300 X 95	
HP 310 X 110	HP 12 X 74		CS 300 X 95 / CS 300 X 102 / CVS 300 X 100	
W 310 X 117,0	W 12 X 79		CS 300 X 109 / CS 300 X 115 / CVS 300 X 113	
HP 310 X 125	HP 12 X 84		CS 300 X 109 / CS 300 X 110	
			CS 300 X 122 / CS 300 X 131	
			CS 300 X 122 / CS 300 X 131 / CS 300 X 138 / CS 300 X 149	



TABELA DE BITOLAS - PERFIL W1 (Padrão Europeu)

Bitola	Espessura				Eixo x-x				Eixo y-y				Esbeltez									
	d mm	bf mm	t _w mm	t _f mm	h mm	d' mm	Área cm ²	lx cm ⁴	Wx cm ³	rx cm	Zx cm ³	ly cm ⁴	Wy cm ³	ry cm	Zy cm	rt cm	lt cm ⁴	ABA- f bf/2tf	ALHA- w d'/tw	Cw cm ⁶	u m ² /m	
6"	W 150 X 13,0	148	100	4,3	4,9	138	118	16,6	635	85,8	6,18	96,4	82	16,4	2,22	25,5	2,60	1,72	10,20	27,49	4,181	0,73
	W 150 X 18,0	153	102	5,8	7,1	139	119	23,4	939	122,8	6,34	139,4	126	24,7	2,32	38,5	2,69	4,34	7,18	20,48	6,683	0,75
	W 200 X 15,0	200	100	4,3	5,2	190	170	19,4	1.305	130,5	8,20	147,9	87	17,4	2,12	27,3	2,55	2,05	9,62	39,44	8,222	0,84
	W 200 X 19,3	203	102	5,8	6,5	190	170	25,1	1.686	166,1	8,19	190,6	116	22,7	2,14	35,9	2,59	4,02	7,85	29,31	11,098	0,85
8"	W 200 X 22,5	225	102	6,2	8,0	190	170	29,0	2.029	197,0	8,37	225,5	142	27,9	2,22	43,9	2,63	6,18	6,38	27,42	13,868	0,85
	W 200 X 26,6	266	133	5,8	8,4	190	170	34,2	2.611	252,3	8,73	282,3	330	49,6	3,10	76,3	3,54	7,65	7,92	29,34	32,477	0,98
	W 200 X 31,3	313	134	6,4	10,2	190	170	40,3	3.168	301,7	8,86	338,6	410	61,2	3,19	94,0	3,60	12,59	6,57	26,50	40,822	0,99
	W 250 X 17,9	251	101	4,8	5,3	240	220	23,1	2.291	182,6	9,96	211,0	91	18,1	1,99	28,8	2,48	2,54	9,53	45,92	13,735	0,94
	W 250 X 22,3	254	102	5,8	6,9	240	220	28,9	2.939	231,4	10,09	267,7	123	24,1	2,06	38,4	2,54	4,77	7,39	37,97	18,629	0,95
	W 250 X 25,3	253	102	6,1	8,4	240	220	32,6	3.473	270,2	10,31	311,1	149	29,3	2,14	46,4	2,58	7,06	6,07	36,10	22,955	0,96
10"	W 250 X 28,4	260	102	6,4	10,0	240	220	36,6	4.046	311,2	10,51	357,3	178	34,8	2,20	54,9	2,62	10,34	5,10	34,48	27,636	0,96
	W 250 X 32,7	258	146	6,1	9,1	240	220	42,1	4.937	382,7	10,83	428,5	473	64,8	3,35	99,7	3,86	10,44	8,02	36,03	73,104	1,13
	W 250 X 38,5	385	147	6,6	11,2	240	220	49,6	6.057	462,4	11,05	517,8	594	80,8	3,46	124,1	3,93	17,63	6,56	33,27	93,242	1,14
	W 250 X 44,8	448	148	7,6	13,0	240	220	57,6	7.158	538,2	11,15	606,3	704	95,1	3,50	146,4	3,96	27,14	5,69	28,95	112,398	1,15
	W 310 X 21,0	303	101	5,1	5,7	292	272	27,2	3.776	249,2	11,77	291,9	98	19,5	1,90	31,4	2,42	3,27	8,86	53,25	21,628	1,05
	W 310 X 23,8	305	101	5,6	6,7	292	272	30,7	4.346	285,0	11,89	333,2	116	22,9	1,94	36,9	2,45	4,65	7,54	48,50	25,594	1,05
	W 310 X 28,3	309	102	6,0	8,9	291	271	36,5	5.500	356,0	12,28	412,0	158	31,0	2,08	49,4	2,55	8,14	5,73	45,20	35,441	1,06
12"	W 310 X 32,7	327	102	6,6	10,8	291	271	42,1	6.570	419,8	12,49	485,3	192	37,6	2,13	59,8	2,58	12,91	4,72	41,12	43,612	1,07
	W 310 X 38,7	387	165	5,8	9,7	291	271	49,7	8.581	553,6	13,14	615,4	727	88,1	3,82	134,9	4,38	13,20	8,51	46,66	163,728	1,31
	W 310 X 44,5	445	166	6,6	11,2	291	271	57,2	9.997	638,8	13,22	712,8	855	103,0	3,87	158,0	4,41	19,90	7,41	41,00	194,433	1,32
	W 310 X 52,0	520	167	7,6	13,2	291	271	67,0	11.909	751,4	13,33	842,5	1.026	122,9	3,91	188,8	4,45	31,81	6,33	35,61	236,422	1,33
	W 360 X 32,9	329	127	5,8	8,5	332	308	42,1	8.358	479,0	14,09	547,6	291	45,9	2,63	72,0	3,20	9,15	7,47	53,10	84,111	1,25
	W 360 X 39,0	390	128	6,5	10,7	332	308	50,2	10.331	585,3	14,35	667,7	375	58,6	2,73	91,9	3,27	15,83	5,98	47,32	109,551	1,26
	W 360 X 44,0	440	171	6,9	9,8	332	308	57,7	12.258	696,5	14,58	784,3	818	95,7	3,77	148,0	4,43	16,70	8,72	44,70	239,091	1,43
	W 360 X 51,0	510	171	7,2	11,6	332	308	64,8	14.222	801,2	14,81	899,5	968	113,3	3,87	174,7	4,49	24,65	7,37	42,75	284,994	1,43
14"	W 360 X 57,8	578	172	7,9	13,1	332	308	72,5	16.143	901,8	14,92	1.014,8	1.113	129,4	3,92	199,8	4,53	34,45	6,56	38,96	330,394	1,44
	W 360 X 64,0	640	203	7,7	13,5	320	288	81,7	17.890	1.031,1	14,80	1.145,5	1.885	185,7	4,80	284,5	5,44	44,57	7,52	37,40	523,362	1,56
	W 360 X 72,0	720	204	8,6	15,1	320	288	91,3	20.169	1.152,5	14,86	1.285,9	2.140	209,8	4,84	321,8	5,47	61,18	6,75	33,47	599,082	1,57
	W 360 X 79,0	790	205	9,4	16,8	320	288	101,2	22.713	1.283,2	14,98	1.437,0	2.416	235,7	4,89	361,9	5,51	82,41	6,10	30,68	685,701	1,58

TABELA DE BITOLAS - PERFIL WJ (Padrão Europeu)

Bitola	Massa linear kg/m	Espessura				Eixo x-x				Eixo y-y				Esbeltez								
		d	bf	t _w	t _f	h	d'	Área	I _x	W _x	r _x	Z _x	I _y	W _y	r _y	Z _y	t _t	I _t	ABA - f	C _w	u	
		mm	mm	mm	mm	mm	mm	cm ²	cm ⁴	cm ³	cm	cm ³	cm ⁴	cm ³	cm	cm	cm	cm ⁴	cm ³	cm ⁶	m ² /m	
W 410 X 38,8	38,8	399	140	6,4	8,8	381	357	50,3	12.777	640,5	15,94	736,8	404	57,7	2,83	90,9	3,49	11,69	7,95	55,84	153,190	1,40
W 410 X 46,1	46,1	403	140	7,0	11,2	381	357	59,2	15.690	778,7	16,27	891,1	514	73,4	2,95	115,2	3,55	20,06	6,25	50,94	196,571	1,41
W 410 X 53,0	53,0	403	177	7,5	10,9	381	357	68,4	18.734	929,7	16,55	1.052,2	1.009	114,0	3,84	176,9	4,56	23,38	8,12	47,63	387,194	1,55
W 410 X 60,0	60,0	407	178	7,7	12,8	381	357	76,2	21.707	1.066,7	16,88	1.201,5	1.205	135,4	3,98	209,2	4,65	33,78	6,95	46,42	467,404	1,57
W 410 X 67,0	67,0	410	179	8,8	14,4	381	357	86,3	24.678	1.203,8	16,91	1.362,7	1.379	154,1	4,00	239,0	4,67	48,11	6,22	40,59	538,546	1,57
W 410 X 75,0	75,0	413	180	9,7	16,0	381	357	95,8	27.616	1.337,3	16,98	1.518,6	1.559	173,2	4,03	269,1	4,70	65,21	5,63	36,80	612,784	1,58
W 460 X 52,0	52,0	450	152	7,6	10,8	428	404	66,6	21.370	949,8	17,91	1.095,9	634	83,5	3,09	131,7	3,79	21,79	7,04	53,21	304,837	1,55
W 460 X 60,0	60,0	455	153	8,0	13,3	428	404	76,2	25.652	1.127,6	18,35	1.292,1	796	104,1	3,23	163,4	3,89	34,60	5,75	50,55	387,230	1,56
W 460 X 68,0	68,0	459	154	9,1	15,4	428	404	87,6	29.851	1.300,7	18,46	1.495,4	941	122,2	3,28	192,4	3,93	52,29	5,00	44,42	461,163	1,57
W 460 X 74,0	74,0	457	190	9,0	14,5	428	404	94,9	33.415	1.462,4	18,77	1.657,4	1.661	174,8	4,18	271,3	4,93	52,97	6,55	44,89	811,417	1,71
W 460 X 82,0	82,0	460	191	9,9	16,0	428	404	104,7	37.157	1.615,5	18,84	1.836,4	1.862	195,0	4,22	303,3	4,96	70,62	5,97	40,81	915,745	1,72
W 460 X 89,0	89,0	463	192	10,5	17,7	428	404	114,1	41.105	1.775,6	18,98	2.019,4	2.093	218,0	4,28	339,0	5,01	92,49	5,42	38,44	1.035,073	1,73
W 530 X 66,0	66,0	525	165	8,9	11,4	502	478	83,6	34.971	1.332,2	20,46	1.558,0	857	103,9	3,20	166,0	4,02	31,52	7,24	53,73	562,854	1,75
W 530 X 72,0	72,0	524	207	9,0	10,9	502	478	91,6	39.969	1.525,5	20,89	1.755,9	1.615	156,0	4,20	244,6	5,16	33,41	9,50	53,13	1.060,548	1,91
W 530 X 74,0	74,0	529	166	9,7	13,6	502	478	95,1	40.969	1.548,9	20,76	1.804,9	1.041	125,5	3,31	200,1	4,10	47,39	6,10	49,26	688,558	1,76
W 530 X 82,0	82,0	528	209	9,5	13,3	501	477	104,5	47.569	1.801,8	21,34	2.058,5	2.028	194,1	4,41	302,7	5,31	51,23	7,86	50,25	1.340,255	1,93
W 530 X 85,0	85,0	535	165	10,3	16,5	502	478	107,7	48.453	1.811,3	21,21	2.099,8	1.263	152,2	3,42	241,6	4,17	72,93	5,03	46,41	845,463	1,77
W 530 X 92,0	92,0	533	209	10,2	15,6	502	478	117,6	55.157	2.069,7	21,65	2.359,8	2.379	227,6	4,50	354,7	5,36	75,50	6,70	46,84	1.588,565	1,94
W 610 X 101,0	101,0	603	228	10,5	14,9	573	541	130,3	77.003	2.554,0	24,31	2.922,7	2.951	258,8	4,76	405,0	5,76	81,68	7,65	51,54	2.544,966	2,17
W 610 X 113,0	113,0	608	228	11,2	17,3	573	541	145,3	88.196	2.901,2	24,64	3.312,9	3.426	300,5	4,86	469,7	5,82	116,50	6,59	48,34	2.981,078	2,18
W 610 X 125,0	125,0	612	229	11,9	19,6	573	541	160,1	99.184	3.241,3	24,89	3.697,3	3.933	343,5	4,96	536,3	5,89	159,50	5,84	45,45	3.441,766	2,19
W 610 X 155,0	155,0	611	324	12,7	19,0	573	541	198,1	129.583	4.241,7	25,58	4.749,1	10.783	665,6	7,38	1.022,6	8,53	200,77	8,53	42,60	9.436,714	2,57
W 610 X 174,0	174,0	616	325	14,0	21,6	573	541	222,8	147.754	4.797,2	25,75	5.383,3	12.374	761,5	7,45	1.171,1	8,58	286,88	7,52	38,63	10.915,665	2,58

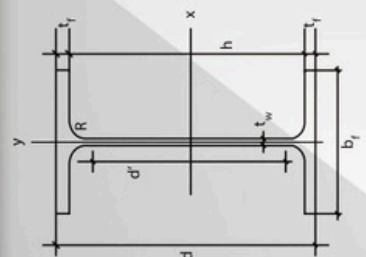

- d = altura do perfil
- bf = largura da aba do perfil
- tw = espessura da alma
- tf = espessura da aba
- h = altura interna
- d' = altura livre da alma
- ÁREA = área da seção
- R = raio de concordância
- I = momento de inércia
- W = módulo de resistência

- r = raio de giração
- Z = módulo de resistência plástico
- rt = raio de giração em relação ao eixo y-y do T formatado pela área da aba mais 1/6 da área da alma
- I_t = momento de inércia à torção
- λ_f = Esbeltez da aba
- λ_w = Esbeltez da alma (parte plana)
- C_w = constante de empenamento
- u = área superficial por meio linear

Principais Normas Técnicas de Referência

Norma	Processo de Fabricação	Finalidade Principal	Norma Similar
NBR	5580	Condução de fluidos	DIN EN 10255
	5581	Fornos de refinarias	ASTM A161
	5582	Fornos de refinarias	ASTM A200
	5584	Condensadores e trocadores de calor	ASTM A199
	5590	Condutores de fluidos com requisitos de qualidade	ASTM A53
	5593	Caldeiras e superaquecedores	ASTM A209
	5594	Caldeiras e superaquecedores de alta pressão	ASTM A192
	5596	Caldeiras e superaquecedores de alta pressão	ASTM A226
	5597	Eletrodutos rígidos, com revestimento, com rosca, pesados e extra pesados	
	5598	Eletrodutos rígidos, com revestimento, com rosca, médios e pesados	
	5599-1	De precisão (autopeças e diversos)	DIN EN 10305-1
	5599-2	De precisão (autopeças e diversos)	DIN EN 10305-2
	5599-3	De precisão (autopeças, móveis e diversos)	DIN EN 10305-3
	5603	Serviços em altas temperaturas	ASTM A335
	6321	Condução de fluidos em altas temperaturas	ASTM A106
	6591	Industriais, perfis redondos, quadrados e retangulares	DIN 2394
	8261	Estruturais	
	8476	De precisão (auto peças e diversos)	DIN 2391
DIN	1626	Evaporadores, aquecedores, condução de gases	
	1629	Caldeiras, aparelhos, reservatórios	
DIN EN	17175	Caldeiras - altas temperaturas	
	10220	Caldeiras, evaporadores, condução de gases, aquecedores	
	10255	Condução de fluidos	NBR 5580
	10305-1	De precisão (autopeças e diversos)	NBR 5599-1
	10305-2	De precisão (autopeças e diversos)	NBR 5599-2
	10305-3	De precisão (autopeças, móveis e diversos)	NBR 5599-3

Norma	Processo de Fabricação	Finalidade Principal	Norma Similar
ASTM	A53	COM OU SEM SOLDA	
	A106	SEM SOLDA	NBR 6321
	A128	COM SOLDA	NBR 5885
	A134	COM SOLDA	
	A135	COM SOLDA	
	A139	COM SOLDA	
	A161	SEM SOLDA	NBR 5581
	A178	COM SOLDA	NBR 5583
	A179	SEM SOLDA	NBR 5534
	A192	SEM SOLDA	NBR 5584
	A199	SEM SOLDA	NBR 5582
	A200	SEM SOLDA	NBR 5593
	A209	SEM SOLDA	NBR 5592
	A210	SEM SOLDA	
	A213	SEM SOLDA	
	A214	COM SOLDA	NBR 5596
	A226	COM SOLDA	
	A252	COM OU SEM SOLDA	
	A333	COM OU SEM SOLDA	NBR 5602
	A334	COM OU SEM SOLDA	NBR 5605
	A335	SEM SOLDA	NBR 5603
	A405	SEM SOLDA	
	A423	COM OU SEM SOLDA	
	A500	COM OU SEM SOLDA	
	A501	SEM SOLDA	
	A513	COM SOLDA	
A519	SEM SOLDA		
A523	COM OU SEM SOLDA		
A524	SEM SOLDA		
A556	SEM SOLDA		
A557	COM SOLDA		
A589	COM OU SEM SOLDA		
5CT	COM OU SEM SOLDA		
5D	SEM SOLDA		
5L	COM OU SEM SOLDA		
2B	COM SOLDA		
API			

PLAST METAL
FERROSOS E NÃO FERROSOS

**FALE
CONOSCO**



CLIQUE PARA SER REDIRECIONADO



(31) 3352-5950



www.plastmetal.com.br

